

# Xgard Bright

Gas Detectors with Display and Relays



Installation, Operation and Maintenance Instructions

M070068  
Issue 5  
December 2020



# Contents

---

1. Introduction.....	1
1.1 Product overview.....	1
1.2 Safety information.....	1
1.3 Storage instructions.....	2
1.4 Certification labels.....	3
1.5 Product dimensions .....	4
1.6 Exploded view .....	5
2. Installation .....	6
2.1 Location .....	6
2.2 Mounting.....	7
2.3 Internal Electrical Connections.....	7
2.4 General Cabling Requirement .....	8
2.5 Cabling Requirement 4 to 20 mA Current Loop .....	8
2.6 Cabling Requirement Multidrop MODBUS.....	9
2.6.1 Calculating acceptable cable length and detector quantities.....	10
2.7 Earthing requirements .....	14
2.8 Cable glands .....	15
2.9 Fitting accessories.....	18
3. Operation .....	19
3.1 Operation panel .....	19
3.2 Key Operation .....	19
3.3 Start up.....	20
3.4 Menu functions.....	21
3.5 Zero .....	22
3.6 Calibrate .....	22
3.7 Routine maintenance .....	23
3.8 Sensor replacement.....	23
4. Specifications.....	25
5. Spare parts .....	26
6. Warranty .....	28



# 1. Introduction

## 1.1 Product overview

**Xgard Bright** is a versatile gas detector for monitoring a wide range of flammable and toxic gases and oxygen levels. **Xgard Bright** incorporates a bright OLED (organic light emitting diode) display and a magnetic wand for easy menu operation.

**Xgard Bright** provides analogue 4-20mA and RS-485 Modbus signals as standard, with optional HART interface. Relays are also fitted for activating local alarms or sending digital signals to control systems.

**Xgard Bright** may be fitted with electrochemical type toxic or oxygen sensors, pellistor-type flammable gas sensors, molecular property spectrometers (MPS), or infrared (IR) hydrocarbon or carbon dioxide gas sensors. Please refer to the product identification label to determine the type of sensor fitted.

Pellistor and MPS sensors are designed to detect flammable gases and vapours in concentrations not exceeding the Lower Explosive Limit (LEL) of the target gas for which the detector is calibrated.

**Xgard Bright** is ATEX and IECEx Ex db IIC T6 Gb flameproof certified for use in Zone 1 or 2 hazardous gas areas and Ex tb IIIC T80°C Db for use in Zone 21 or 22 hazardous dust areas.

## 1.2 Safety information

### Safety information relevant to Ex requirements:

- WARNING – POTENTIAL ELECTROSTATIC CHARGING HAZARD. The painted aluminium enclosure constitutes a potential electrostatic hazard and the equipment must only be cleaned using a damp cloth.
- The cable gland must be installed before use and must comply with the requirements of standards EN60019-0 and EN60079-1 with minimum IP66 ingress protection.
- Unused cable entries must be sealed using an ATEX/IECEx Exd certified stopping plug with minimum IP66 ingress protection.
- Only cables of types specific in these instructions can be used.
- External earthing should be considered and installed according to these instructions before use.
- WARNING – DO NOT OPEN WHEN AN EXPLOSIVE ATMOSPHERE IS PRESENT.

# Introduction

- The lid on **Xgard Bright** must be kept tightly closed until power to the detector is isolated otherwise ignition of a flammable atmosphere can occur. Before removing the cover for maintenance, ensure the surrounding atmosphere is free of flammable gases or vapours.

## General safety information

- **Xgard Bright** gas detectors must be installed, operated and maintained in strict accordance with these instructions, warnings, label information, and within the limitations stated.
- **Xgard Bright** detectors are designed to detect gases or vapours in air, and not inert or oxygen deficient atmospheres. **Xgard Bright** oxygen detectors can measure in oxygen deficient atmospheres. Please note: the exception is for IR versions of **Xgard Bright** which do not require the presence of oxygen to function. IRCO<sub>2</sub> and IR flammable gas **Xgard Bright** works perfectly well in inert atmospheres.
- Electrochemical cells used in toxic and oxygen versions of **Xgard Bright** contain small volumes of corrosive electrolyte. Care should be observed when replacing cells to ensure that the electrolyte does not come into contact with skin or eyes.
- Maintenance and calibration operations must only be performed by qualified service personnel.
- Only genuine Crowcon replacement parts must be used, substitute components may invalidate the certification and warranty of the detector.
- **Xgard Bright** detectors must be protected from extreme vibration, and direct sunlight in hot environments as this may cause the temperature of the detector to rise above its specified limits and cause premature failure. A sunshade is available for **Xgard Bright**.  
**Note:** If the sinter is subjected to direct water jet the product must be bump tested with gas to ensure correct operation.
- This equipment must not be used in a Carbon Disulphide atmosphere.

## 1.3 Storage instructions

Some types of sensor available with **Xgard Bright** have limited life when left un-powered and/or may be adversely affected by temperature extremes or environmental contamination. Ideal storage conditions are 20°C and 60%RH. Do not expose sensors to contaminants such as silicones, lead compounds and strong solvents such as isopropanol. It is strongly recommended detectors are installed and powered within 3 months of purchase.

## 1.4 Certification labels



ATEX and IECEx certification label

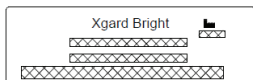

Gas name and range label

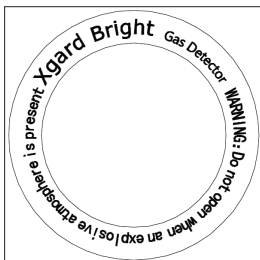

Warning label

Diagram 1: **Xgard Bright** Certification Labels

## 1.5 Product dimensions

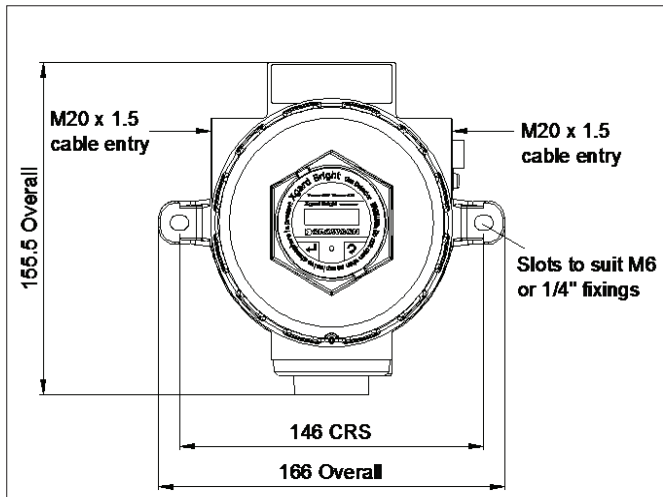

All dimensions in millimetres

Diagram 2: *Xgard Bright* dimension view



## 1.6 Exploded view

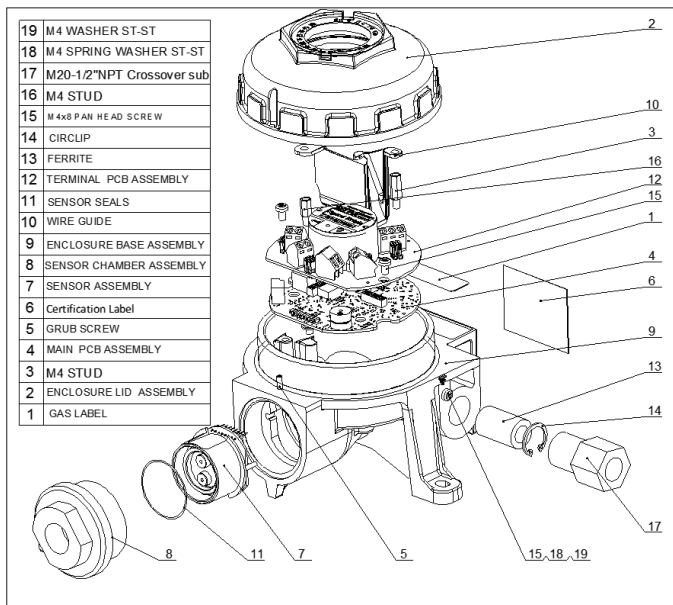

Diagram 3: Xgard Bright exploded view

## 2. Installation

---

### WARNING

This detector is designed for use in Zone 1 and Zone 2 or Zone 21 and Zone 22 hazardous areas, and is certified Ex db IIC T6 Gb and Ex tb IIIC T80°C Db for operation up to 70°C (158°F). Installation must be in accordance with the recognized standards of the appropriate authority in the country concerned. For further information please contact Crowcon. Prior to carrying out any installation work ensure local regulations and site procedures are followed.

### 2.1 Location

The detector should be mounted where the gas to be detected is most likely to be present. The following points should be noted when locating gas detectors:

- To detect gases which are lighter than air, detectors should be mounted at high level and Crowcon recommend the use of a collector cone (**Part No. C01051**).
- To detect heavier than air gases, detectors should be mounted at low level.
- When locating detectors consider the possible damage caused by natural events e.g. rain or flooding. For detectors mounted outdoors Crowcon recommend the use of a Spray Deflector (**Part No. C01052**).
- Consider ease of access for functional testing and servicing.
- Consider how the escaping gas may behave due to natural or forced air currents. Mount detectors in ventilation ducts if appropriate.
- Consider the process conditions. For example, butane is normally heavier than air, but if released from a process which is at an elevated temperature and/or pressure, the gas may rise rather than fall.
- Location of oxygen sensors requires knowledge of the gas that may displace the oxygen. For example, carbon dioxide is denser than air and therefore is likely to displace oxygen from low levels upwards.
- Sensors should be mounted at head height (1.5m nominally) to detect gases of a similar density to air, assuming that ambient conditions and the temperature of the target gas are nominally 20°C.

The placement of sensors should be determined following advice of experts having specialist knowledge of gas dispersion, the plant processing equipment as well as safety and engineering issues. **The agreement reached on the locations of sensors should be recorded.**

## 2.2 Mounting

**Xgard Bright** should be installed at the designated location with the sensor pointing down. This ensures that dust or water will not collect on the sensor and stop gas entering the cell. Care should be taken when installing the detector to avoid damaging the painted surface of the enclosure.

There are two M20x1.5 entry ports on the base. One entry port will be used for power supply input during normal operation. Unused port will be blocked by blind plug, or can be used to connect external alarm device or be used for connecting devices to the multi drop communications. End user will only use certified cable gland for installation.

## 2.3 Internal Electrical Connections

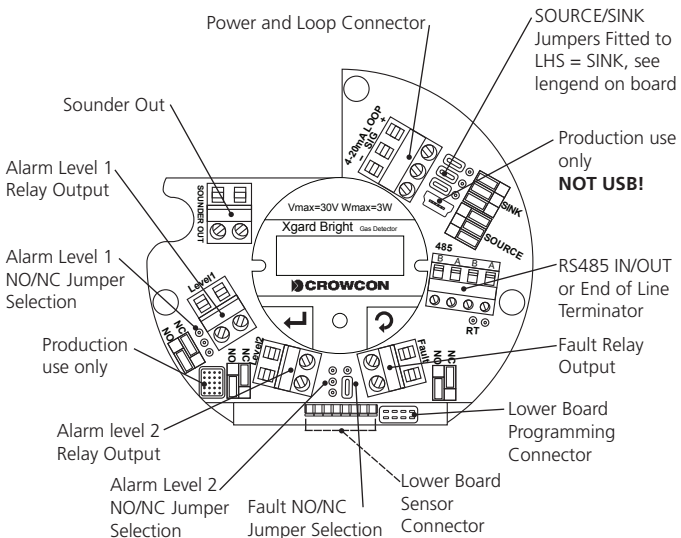

Diagram 4: **Xgard Bright** internal electrical connections

# Installation

**NOTE: the mini USB socket is not intended for customer use, connecting this to a computer is likely to damage both Xgard Bright and the computer.**

## 2.4 General Cabling Requirement

Cabling to **Xgard Bright** must be in accordance with the recognised standards of the appropriate authority in the country concerned and meet the electrical requirements of the detector.

Suitable explosion proof glands must be used. Alternative cabling techniques, such as steel conduit, may be acceptable provided appropriate standards are met.

## 2.5 Cabling Requirement 4 to 20 mA Current Loop

Fulfils the requirements for 4 to 20 mA current loop and HART connections, allows for connection and powering of accessory beacon or sounder subject to current consumption, cable resistance and panel voltage. Current consumption should consider worst case e.g. when the accessories are powered.

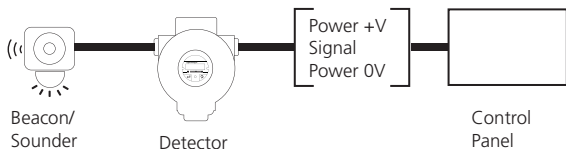

### Example Calculation 1

What is the longest cable for a bright to operate using point to point connection and powering a sounder with 250mA current consumption. Use parameters of 1.5mm<sup>2</sup> cable, where the controller has a guaranteed minimum output voltage of 18V.

This type of cable has resistance of 12.1Ω/km, therefore the there and back cable resistance is 24.2. **Xgard Bright** has min voltage requirement of 10V.

The alarm 2 current for **Xgard Bright** (pellistor) is 95mA, **Xgard Bright** (IR) is 90mA, **Xgard Bright** (MPS) is 34mA and the sounder output max current is 0.25 A, so a total current for the pellistor in alarm driving the sounder output is:

Max current = 0.25 + 0.095 = 0.345 A.

$$18V = 10V + (0.345 \times 24.2 \times d), \text{ where } d \text{ is distance in km}$$

$$d = (18 - 10) / (0.345 \times 24.2) = 0.958 \text{ km}$$

### Example Calculation 2

As example calculation 1 but without the sounder.

**Xgard Bright** pellistor requires a dc supply of 10-30V, at max current in alarm 2 of 95mA. Ensure there is a minimum of 10V at the detector, taking into account the voltage drop due to cable resistance. For example, a nominal dc supply at the control panel of 24V has a guaranteed minimum supply of 18V. The maximum voltage drop is therefore 8V. **Xgard Bright** can demand up to 95mA and so the maximum loop resistance allowed is approx 80Ω.

A 1.5mm<sup>2</sup> cable will typically allow cable runs up to 3.3km. Table 1 below shows the maximum cable distances given typical cable parameters for this example calculation.

C.S.A.	Resistance (Ohms per km)		Max. Distance (km)	
	Awg	Cable	Loop	
mm <sup>2</sup>				
1.0	17	18.1	36.2	2.2
1.5	15	12.1	24.2	3.3
2.5	13	7.4	14.8	5.4

Table 1: maximum cable distances for typical cables

## 2.6 Cabling Requirement Multidrop MODBUS

This fulfils the requirements of multidrop communications back to a compatible addressable control panel. Due to current consumption of multiple detectors powering of accessories via the detector sounder/beacon output or relay contact must be avoided.

Each detector must be configured with a unique node address when connected in an addressable network.

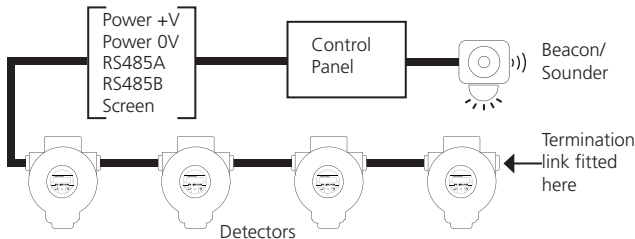

# Installation

Four connections are required for multidrop operation: a 24V/0V dc power supply, and RS-485 A and B connections to the appropriate terminals. Two sets of RS-485 terminals and a spare cable gland entry (sealed with a stopping gland by Crowcon) are provided to enable signals to be 'looped' to the next detector easily.

To minimise cable voltage drops (and to maximise the potential total cable length and detector network quantity) large cross-sectional area (c.s.a.) cable must be used for the 24V/0V power connection. Crowcon recommends cable with 1.5mm<sup>2</sup> conductors is used for the power.

Twisted pair and screened cable is recommended for the RS485 signals. The screen is to be earthed at the control panel only, but continuity must be maintained through the detectors extending to the end of line detector. The end of line detector also needs a terminating resistor link fitted to the top PCB (the terminals labelled RT).

Specialist cables are available combining large c.s.a. conductors for power and twisted-pair signal cables for RS-485 communications, however in some cases it may be necessary to run separate cables to the detector network. In this instance it may be most practical to terminate the two cables within a junction box near to each detector, and drop and single/combined cable with smaller power conductors locally to the detector.

On large networks, or where long cable runs are required, it may be necessary to power groups of detectors via separate power supplies placed locally around the installation. Where this method is deployed, the 24V/0V cables for each group of detector must be isolated to their dedicated local power supply.

## 2.6.1 Calculating acceptable cable length and detector quantities

It is essential before attempting installation to calculate the voltage to each detector given the power supply voltage, cable resistance and cable lengths required. The more detectors connected to the linear bus, the greater the power required to run the system. To calculate the power required for a particular setup, it is necessary to know the cable resistance between each pair of detectors. A current of a maximum 0.07A (toxic) must be allowed for each 'hop' between each detector (this assumes the highest power configuration for each detector: pellistor sensor). The voltage to be applied can be calculated by estimating the voltage drop across each detector 'hop' – at the end at least 10V must remain to ensure that the last **Xgard Bright** detector functions correctly.

Follow the steps outlined below and the sample calculation shown in the next section to calculate for specific applications.

1. The voltage must not fall below 10V, so start the calculation by setting the voltage at the last detector in the line at that value.
2. Each detector may draw up to 0.070A. Calculate the cable voltage loss of the first 'hop' between detectors by taking the current 0.070A and multiply this by the cable resistance of the 'hop' between the last and the last but one detector.
3. Add this voltage drop to the initial 10V to get the lowest acceptable voltage at the last but one detector. Add 0.070A to the value for the 'aggregate current' to get to 0.14A, the minimum current running through the last but one 'hop' of the bus. Multiply this by the cable resistance for the last but one 'hop' to get the next voltage drop.
4. Repeat this process for each detector, accumulating the voltage losses that will occur between each detector.
5. The maximum detector voltage of 30V must not be exceeded.

### Example Calculation using the above rules

How many **Xgard Bright** can be put on a multidrop cable if:

1. The controller has a guaranteed minimum output voltage of 18V.
2. Cable resistance is 12.1 $\Omega$ /km.
3. There is 20m between each detector and 20 m from the final detector to the controller.
4. The worst case current draw (**Xgard Bright** toxic) is 70mA.

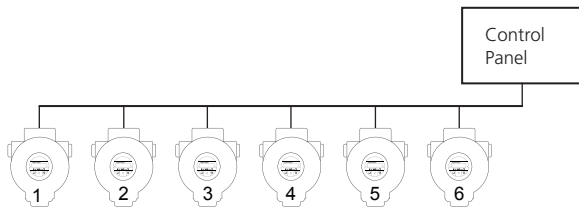

## Installation

So consider the voltage to the detector furthest ( $n=1$ ) from the controller has to be 10V. Each cable segment has a there and back resistance of  $12.1 \times 2 \times 20/1000 = 0.484$  ohms.

So the cable volts drop to detector ( $n=2$ ) is:

$$V_c = 0.070 \times 0.484 = 0.03388V$$

$$V(n=2) = V(n=1) + V_c = 10.0338 V$$

Now the voltage at detector ( $n=3$ ) is

$V(n=3) = V(n=2) + 2V_c$  (as there is twice the current supplied through this cable segment)

$$V(n=3) = 10.03388 + 0.06776 = 10.10164 V$$



Tabulating the results for each detector position we get:

Detector	Voltage at Detector (V)	Cable current (A)	Cable voltage drop (V)
N=1	10	0.070	0.03388
N=2	10.03388	0.14	0.06776
N=3	10.10164	0.21	0.10164
N=4	10.20328	0.28	0.13552
N=5	10.3388	0.35	0.1694
N=6	10.5082	0.42	0.20328
N=7	10.71148	0.49	0.23716
N=8	10.94864	0.56	0.27104
N=9	11.21968	0.63	0.30492
N=10	11.5246	0.7	0.3388
N=11	11.8634	0.77	0.37268
N=12	12.23608	0.84	0.40656
N=13	12.64264	0.91	0.44044
N=14	13.08308	0.98	0.47432
N=15	13.5574	1.05	0.5082
N=16	14.0656	1.12	0.54208
N=17	14.60768	1.19	0.57596
N=18	15.18364	1.26	0.60984
N=19	15.79348	1.33	0.64372
N=20	16.4372	1.4	0.6776
N=21	17.1148	1.47	0.71148
N=22	17.82628	1.54	0.74536
Power Supply	18.57164		

So 22 detectors just exceeds the power supply guarantee voltage, therefore the answer for a safe maximum number of detectors is 21.

If this is not a convenient solution then there is scope for increasing the number by changing the power supply or using thicker (lower resistance) cable.

## 2.7 Earthing requirements

Earth terminals are provided on the outside of the **Xgard Bright** enclosure adjacent to the top-right cable entry, and internally adjacent to the left-hand sounder out cable connector. For electrical safety it is essential that the **Xgard Bright** enclosure is bonded to earth, usually using the external earth lug, if an earth cable is provided in the field cable the internal earth point can be used. The grounding terminal connection must be tightened using a torque screwdriver to 10Nm; secured using an M4 x 6mm screw, a plain washer and a star/lock washer. Earthing cables must be 4mm<sup>2</sup> or greater in cross-sectional area.

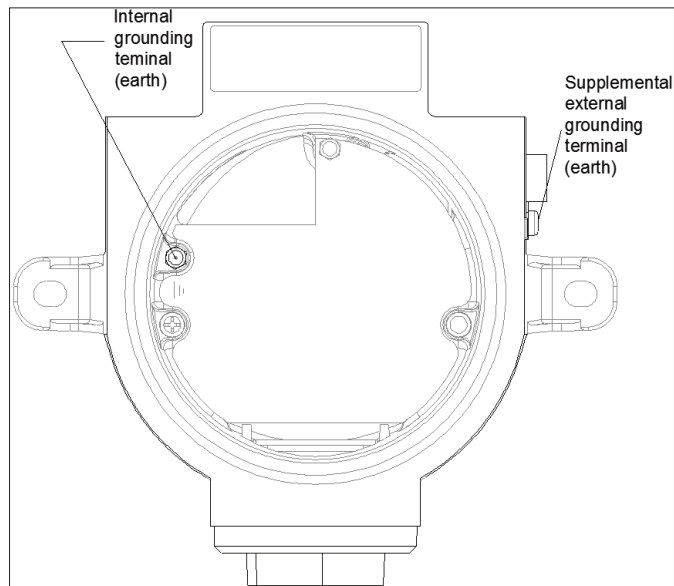
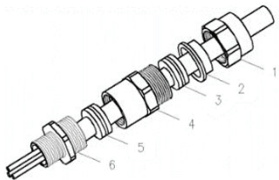

Diagram 5: Earthing Connections

## 2.8 Cable glands

Instructions for installing appropriate certified glands with unarmoured and armoured cable is given below.

### Unarmoured cable



1. Backnut
2. Compression Spigot
3. Seal
4. Middle Nut
5. Inner Seal
6. Entry

Allow sufficient length of cable to the detector, fit shroud if required, pass the cable through cable gland.

1. Screw the gland Entry into the **Xgard Bright** M20 cable Entry. Using two spanners or wrenches, hold the gland Entry in position to prevent rotation and tighten the Middle Nut until resistance is felt between the Seal and cable. Then turn the Middle Nut through a further half to one full turn to complete the Inner Seal.

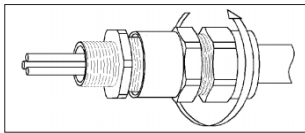

2. Hold the Middle Nut in position to prevent rotation and tighten the Backnut until resistance is felt between the Seal and cable, then turn the Middle Nut through a further half to one full turn to complete the Outer Seal.

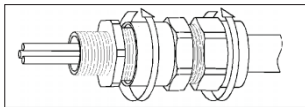

# Installation

## Armoured cable

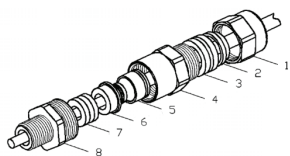

1. Backnut
2. Compression Spigot
3. Compression seal
4. Middle Nut
5. Reversible Armour Clamping Ring
6. Armour Spigot
7. Inner seal
8. Entry

1. Expose the armour/braid "A" by stripping the cable's armoured / woven layer and removing the cable filler.

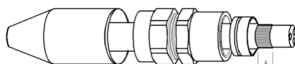

A=15mm

2. Push the cable through the Armour Spigot. Spread armour/braid over the Armour Spigot until the end of the armour/braid is up against the shoulder of the armour cone. Position the Armour Clamping Ring.

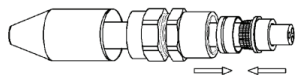

3. Remove the Inner seal from the Entry. Place the Entry over the Armour Spigot. Move the Middle Nut to meet the Entry.

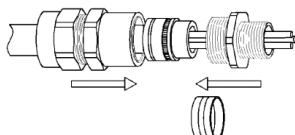

4. Hold the Entry in position with a spanner/wrench to prevent rotation. Hand tighten the middle Nut to the Entry and turn a further half to one full turn with a spanner/wrench.

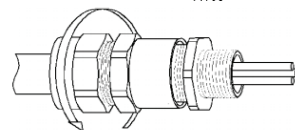

5. Unscrew the Middle Nut and visually inspect that the armour/braid has been successfully clamped between the Armour Spigot and the Armour

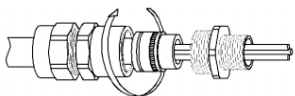

Clamping Ring. If armour/braid not clamped, repeat assembly.

6. Remove Entry and refit Inner Seal, replace Entry and re-assemble Middle Nut onto the entry component. Tighten up the Middle Nut by hand then using a wrench/spanner a further 1 to 4 turns until fully tight.

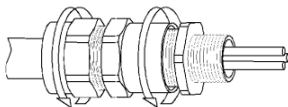

### Notes:

1. These instructions are provided for general guidance only. It is essential that the instructions provided by the cable gland manufacturer are strictly adhered to.
2. Only cable glands ATEX and IECEx certified Exd Flameproof may be used with **Xgard Bright**.
3. Cable glands must have a minimum ingress protection rating of IP66.

# Installation

## 2.9 Fitting accessories

### Collector cone (product code C01051)



Aids detection of lighter than air gases such as hydrogen or methane. Includes a pipe spigot for application of bump test gas.

### Spray deflector (product code C01052)



For outdoor installations and sensor protection from water sprays.

### Weatherproof cap (product code C01442)



For use offshore or very wet environments.

### Flow adaptor (product code C01339)



For use in sampling applications.

### Sun shield (product code C011063)



Prevents against excessive heat build-up due to direct sunlight.

### Calibration adaptor (product code C03005)



Enables application of calibration gas to the sensor.

## 3. Operation

### WARNING

Prior to carrying out any work ensure local regulations and site procedures are followed. Never attempt to open the detector or enclosure base when flammable gas is present. Ensure that the associated control panel is inhibited so as to prevent false alarms.

### 3.1 Operation panel

The **Xgard Bright** operation panel comprises an OLED screen, a three-colour status LED and two magnetically operated Hall Effect switches. The screen displays white characters on a black background and can be viewed clearly even in bright sunlight. Reversed white screen saver will be activated in normal detection condition while long time no operation.

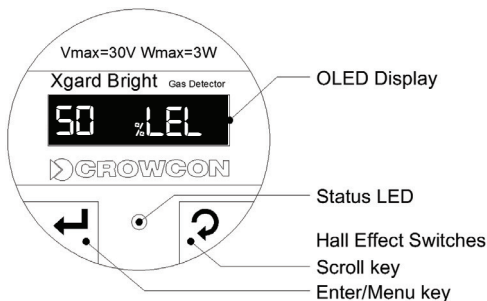

Diagram 6: **Xgard Bright** operation panel

#### LED Indication

The Tri-Colour LED provides the following indications:

GREEN	ORANGE	RED
Normal Operation	Fault Condition	Detector in Alarm

### 3.2 Key Operation

Key response has time dependency, two kinds of action would be generated depend on how long time the key was hold.

- Short-time action event, magnet applied and removed in 2 seconds.
- Long-time action event, magnet applied and hold for more than 2 seconds, a short beep will indicate 2 seconds is complete.

## 3.3 Start up

When the **Xgard Bright** is powered up, the unit will perform internal diagnostic checks whilst the display will show a Crowcon logo. This procedure will be displayed for about 45 seconds followed by displaying a warming up status for about 120 seconds.

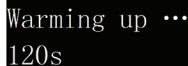

Warming up ...  
120s



**CROWCON**

Diagram 7: Start up and Warming up

If the diagnostic checks were successful, the gas status screen will be displayed. In normal operation the gas level will be indicated on the display.

Use the supplied magnetic wand to select the Scroll key to move between the information screens shown below.



50 %LEL 16 PPM 20.9 %VOL 4.00 MA  
► CROWCON ► CROWCON ► CROWCON ► CROWCON

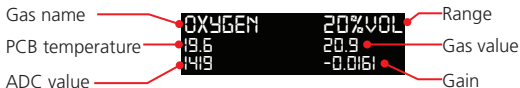

Gas name — OXYGEN — Range  
PCB temperature — 19.6 — Gas value  
ADC value — 1419 — Gain



**CROWCON**



① SN: 00000000000000000000  
② F: 2.10 R: 0.3 H: 151003  
③  
④  
⑤ VOLT: 23V DT: 20171206  
⑥

1. Serial number
2. Firmware version, Hardware version
3. HART ID
4. Detector 485 Address, 485 packets received, 485 packets address match, Polling address
5. Detector supply voltage
6. Due time in format YYYYMMDD

Diagram 8: Gas status screen



### 3.4 Menu functions

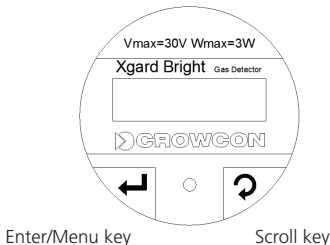

From the gas display screen, use the supplied magnetic wand to select the Enter/Menu key to show password screen.

Enter the password: '0000' to display the following menu. Select the Scroll key to change the displayed number, and the Enter/Menu key to move to the next integer. Hold the Enter/Menu key for two seconds to enter the menu.

Use Scroll key to move down the menu options list and to change the numbers in any screen. Hold the scroll key for 2 seconds to move up the menu options.

1. Zero: to zero the sensor.
2. Cal gas: to calibrate the sensor.
3. To main menu: returns the display to the main gas screen.
4. Set Alarm 1: to adjust the first alarm threshold.
5. Set Alarm 2: to adjust the second alarm threshold.

**Note:** When Alarm 2 threshold is set lower than the Alarm 1 threshold both alarms are falling, e.g. for oxygen when Alarm level 1 = 19.0 and Alarm level 2 = 17.5.

When Alarm 1 is less than Alarm 2, both alarms are rising.

6. Clr Loc Alarm: to de-activate the 'Sounder Out' output (used to silence alarms even if the gas level remains above the alarm thresholds).
7. Chn/Eng: switch between Chinese and English display.
8. Set 485 Addr: sets the node address of the detector for Modbus operation.
9. Test Relay: adjust the analogue output signal: Dec/OK to decrease, Add/Back to increase. The alarm relays will activate at the appropriate point.
  - a. Adj Loop mA: errors in the zero-level analogue output signal can be adjusted by up to +/-2mA.

## Operation

Hold Enter/Menu key for 2 seconds to enter menu or confirm changes to (eg) alarm levels. After applying the magnet a short beep will indicate when 2 seconds is complete and the magnet can be removed. A long beep will then confirm the change.

Hold the Enter/Menu key for 2 seconds to exit the menu from any point.

### 3.5 Zero

**Note:** Purge sensor with the appropriate gas before zeroing.

This function should only be carried out in 'clean air' and allows the **Xgard Bright** to be zeroed at any time.



To carry out the zero function, press 'Next'. The zeroing screen will be displayed.

When zeroing is complete a pass or fail screen will be displayed. Press 'OK' to return to the Main menu.

**Note: Calibration of oxygen channels:** Zeroing is not required for an oxygen instrument and selecting zero will not function.

### 3.6 Calibrate

In main menu status chose 'Cal gas', the calibration level screen will be displayed.



To cancel the calibration, long press the right key '/Back', The Main menu will be displayed. Adjust the value shown to match the calibration gas concentration, to continue, long press left key '/OK' to accept the calibration level.

Connect the calibration cap to the **Xgard Bright** and then connect the appropriate gas cylinder to the adapter. When the gas reading is stable press the right key 'Mark'. To complete calibration press left key 'DONE'.



If the calibration was successful the success symbol will be displayed and return to the main menu.

For flammable gas IR detectors, methane IR measurements are calibrated using methane, but for all other flammable gas types Propane should be used to calibrate **Xgard Bright IR**.

For flammable gas MPS detectors, all measurements are calibrated according to our technical note available at [Crowcon.com/fixed/Bright](http://Crowcon.com/fixed/Bright).

### 3.7 Routine maintenance

**Warning: prior to carrying out any work ensure local regulations and site procedures are followed. Never attempt to unscrew the lid or sensor retainer with power applied or when flammable gas may be present. Ensure the associated control panel is inhibited so as to prevent false alarms.**

Service and maintenance work should be carried out by Crowcon, an approved service centre or by suitably qualified and trained personnel.

Site practices and conditions will dictate the frequency with which detectors are tested and calibrated. Crowcon recommends that detectors are gas tested at least every 6 months and re-calibrated as necessary.

Do not use damaged components or damaged electrochemical cells.

The sinter should be inspected regularly, and replaced if it has become contaminated. A blocked sinter may prevent gas from reaching the sensor.

Ensure that the sensor retainer and junction box lid O-rings are present and in good condition in order to maintain the ingress protection of the product.

### 3.8 Sensor replacement

The operational life of sensors depends on the application and amount of gas to which the sensor has been exposed. Under normal conditions (6 monthly calibration with periodic exposure to test gas) the typical life expectancy of sensors is as follows:

- Oxygen sensors: 2 years.
- Electrochemical toxic gas sensors: 2-3 years.
- Pellistors: 3-5 years.
- IR sensors: 10+ years.
- MPS sensors: 5+ years

Pellistors can suffer from loss of sensitivity when there is a presence of poisons or inhibitors such as silicones, sulphides, chlorine, lead or halogenated hydrocarbons. Crowcon use poison resistant pellistors to maximise operational life, however in applications where such compounds are present we recommend the use of IR sensors which are immune to such poisons and inhibitors.

Toxic and flammable gas sensor modules should be replaced when they fail to calibrate or show a very low response to test gas. Oxygen sensors must be replaced every two years.

To replace a sensor module:

1. Switch off and isolate power to the detector.
2. Loosen the grub-screw and unscrew the sensor retainer.
3. Carefully withdraw the sensor module by grasping the top and bottom of the moulding.
4. Fit the replacement sensor (having checked that the part number matches that stated on the detector junction box label). Take care to align the locating pins correctly with the slots in the **Xgard Bright** enclosure.
5. Re-fit the sensor retainer having first inspected the sinter to make sure that it has not become contaminated. Contaminated sinters must be replaced as any blockages may prevent gas from reaching the sensor. Ensure the grub-screw is re-secured.
6. Zero and calibrate the new sensor.

**Warning: Xgard Bright sensor modules are NOT compatible with Xgard sensor Modules.**

## 4. Specifications

<b>Enclosure material</b>	ADC 12 aluminium alloy
<b>Dimension</b>	156 x 166 x 109mm (6.1 x 6.5 x 4.3inch)
<b>Weight</b>	Aluminium alloy 1kg (2.2lbs)
<b>Ingress protection</b>	IP65 & IP66 (with weatherproof cap)
<b>Cable entry</b>	2x M20 (stopping plug fitted to left-side entry) or supplied with ½" NPT adapters
<b>Power</b>	12-30Vdc. 3W max
<b>Electrical output</b>	4-20mA current sink or source RS-485 Modbus RTU HART (optional)
<b>Relays</b>	Alarm 1, Alarm 2, Fault SPDT contacts rated 1A 24Vdc
<b>Sounder Out:</b>	MOSFET open-collector drive. 24Vdc (nominally), 0.7A maximum load
<b>Operating temperature</b>	-40°C to +70°C (-40°F to 158°F) Note: sensor operating temperatures vary. Refer to the sensor module datasheet or contact Crowcon for specific sensor data.
<b>Humidity</b>	0 to 95% RH, non-condensing
<b>Repeatability</b>	+/- 2% FSD
<b>Zero drift</b>	+/- 2% FSD per year maximum
<b>Approval codes</b>	ATEX and IECEx Ex II 2G Ex db IIC T6 Gb Ex II 2D Ex tb IIIC T80°C Db Certificate numbers: TUV 16 ATEX 7908 X IECEx TUR 16.0035 X
<b>Standards</b>	EN60079-0:2012 + A11:2013 EN60079-1:2014 EN60079-31:2014 IEC60079-0:2017 Edition 7 IEC60079-1:2014-06 IEC60079-31:2013
<b>Zones</b>	Certified for use in Zone 1 and Zone 2 or Zone 21 and Zone 22 areas
<b>EMC compliance</b>	EN50270:2015

## 5. Spare parts

Part No	Description
C01647	<b>Xgard Bright</b> Spare/Replacement M4 Earth Stud Assembly
M04885	<b>Xgard Bright</b> Spare Sensor Seal
M03871	<b>Xgard Bright</b> Threaded Hex Spacer 15mm (M4)
M03870	<b>Xgard Bright</b> Threaded Hex Spacer 10mm (M4)
M03760	<b>Xgard Bright</b> Spare M4 x 8 Posi Pan Head Screw (Customer may require 7)
M03810	<b>Xgard Bright</b> M3x6 Grub Screw (Customer may require 2)
M02125	<b>Xgard Bright</b> Spare M20 to 1/2" NPT Adapter
C03756	<b>Xgard Bright</b> Cro-Mag
MIS99033	<b>Xgard Bright</b> Allen Key
S015100/S	XGB Spare Sensor Module Methane 0-100% l <sub>el</sub> CH <sub>4</sub> (pellistor)
S015101/S	XGB Spare Sensor Module Oxygen 0-25% vol O <sub>2</sub>
S015107/S	XGB Spare Sensor Module Hydrogen Sulphide 0-10ppm H <sub>2</sub> S
S015102/S	XGB Spare Sensor Module Hydrogen Sulphide 0-25ppm H <sub>2</sub> S
S015103/S	XGB Spare Sensor Module Hydrogen Sulphide 0-50ppm H <sub>2</sub> S
S015104/S	XGB Spare Sensor Module Hydrogen Sulphide 0-100ppm H <sub>2</sub> S
S015105/S	XGB Spare Sensor Module Hydrogen Sulphide 0-200ppm H <sub>2</sub> S
S015109/S	XGB Spare Sensor Module Carbon Monoxide 0-50ppm CO
S015110/S	XGB Spare Sensor Module Carbon Monoxide 0-100ppm CO
S015111/S	XGB Spare Sensor Module Carbon Monoxide 0-200ppm CO
S015112/S	XGB Spare Sensor Module Carbon Monoxide 0-250ppm CO
S015113/S	XGB Spare Sensor Module Carbon Monoxide 0-500ppm CO
S015114/S	XGB Spare Sensor Module Carbon Monoxide 0-1000ppm CO
S015115/S	XGB Spare Sensor Module Carbon Monoxide 0-2000ppm CO
S015120/S	XGB Spare Sensor Module LPG 0-100% l <sub>el</sub> (pellistor)
S015121/S	XGB Spare Sensor Module Hydrogen 0-100% l <sub>el</sub> H <sub>2</sub> (pellistor)
S015130/S	XGB Spare Sensor Module Pentane 0-100% l <sub>el</sub> C <sub>5</sub> H <sub>12</sub> (pellistor)
S015118/S	XGB Spare Sensor Module Methane IR 0-100% LEL

S015123/S	XGB Spare Sensor Module Propane IR 0-100% LEL
S015128/S	XGB Spare Sensor Module Butane IR 0-100% LEL
S015122/S	XGB Spare Sensor Module Pentane IR 0-100% LEL
S015129/S	XGB Spare Sensor Module LPG IR 0-100% LEL
S015135/S	XGB Spare Sensor Module Flam MPS 0-100% LEL

## 6. Warranty

---

### **Product Use:**

Every effort has been made to ensure the accuracy of this document at the time of printing. In accordance with the company's policy of continued product improvement Crowcon Detection Instruments Limited reserves the right to make product changes without notice. The products are routinely subject to a programme of testing which may result in some changes in the characteristics quoted. Technical information contained in this document or otherwise provided by Crowcon are based upon records, tests, or experience that the company believes to be reliable, but the accuracy, completeness, and representative nature of such information is not guaranteed. Many factors beyond Crowcon Detection Instruments' control and uniquely within user's knowledge and control can affect the use and performance of a Crowcon product in a particular application.

As the products may be used by the client in circumstances beyond the knowledge and control of Crowcon Detection Instruments Limited, we cannot determine the relevance of these to an individual customer's application. It is the clients' sole responsibility to carry out the necessary tests to evaluate the usefulness of the products and review all applicable regulations and standards to ensure their safety of operation in a particular application.

### **Warranty, Limited Remedy, and Disclaimer:**

Unless an additional warranty is specifically stated on the applicable Crowcon product packaging or product literature, Crowcon warrants that each Crowcon product meets the applicable Crowcon product specification at the time of shipment. CROWCON MAKES NO OTHER WARRANTIES OR CONDITIONS, EXPRESS OR IMPLIED, INCLUDING, BUT NOT LIMITED TO, ANY IMPLIED WARRANTY OR CONDITION OF MERCHANTABILITY OR FITNESS FOR A PARTICULAR PURPOSE OR ANY IMPLIED WARRANTY OR CONDITION ARISING OUT OF A COURSE OF DEALING, CUSTOM OR USAGE OF TRADE. If the Crowcon product does not conform to this warranty, then the sole and exclusive remedy is, at Crowcon's option, replacement of the Crowcon product or refund of the purchase price.

### **Limitation of Liability:**

Except where prohibited by law, Crowcon will not be liable for any loss or damage arising from the Crowcon product, whether direct, indirect, special, incidental or consequential, regardless of the legal theory asserted, including warranty, contract, negligence or strict liability.



Our postal address is:

Crowcon Detection Instruments Ltd. (UK Head Office)

172 Brook Drive

Milton Park

Oxfordshire

OX14 4SD







### **UK Office**

Crowcon Detection Instruments Ltd  
172 Brook Drive,  
Milton Park,  
Abingdon  
Oxfordshire  
OX14 4SD  
Tel: +44 (0) 1235 557700  
Fax: +44 (0) 1235 557749  
Email: sales@crowcon.com  
Website: www.crowcon.com

### **USA Office**

Crowcon Detection Instruments Ltd  
1455 Jamike Ave, Suite 100  
Erlanger  
KY 41018  
Tel: +1 859 957 1039 or 1 800 527  
6926  
Fax: +1 859 957 1044  
Email: salesusa@crowcon.com  
Website: www.crowcon.com

### **Netherlands Office**

Crowcon Detection Instruments Ltd  
Vlambloem 129  
3068JG, Rotterdam  
Netherlands  
Tel: + 31 10 421 1232  
Fax: + 31 10 421 0542  
Email: eu@crowcon.com  
Website: www.crowcon.com

### **Singapore Office**

Crowcon Detection Instruments Ltd  
Block 194, Pandan Loop  
#06-20 Pantech Industrial Complex  
Singapore 128383  
Tel: + 65 6745 2936  
Fax: +65 6745 0467  
Email: sales@crowcon.com.sg  
Website: www.crowcon.com

### **China Office**

Crowcon Detection Instruments Ltd  
(Beijing)  
Unit 316, Area 1, Tower B, Chuangxin  
Building  
12 Hongda North Road, Beijing Eco-  
nomic Technological Development Area  
Beijing, China 100176  
Tel: +86 10 6787 0335  
Fax: +86 10 6787 4879  
Email: saleschina@crowcon.cn  
Website: www.crowcon.com